



MADE IN GERMANY



ENVIRONMENTAL TECHNOLOGIES

# GRADER TOOLS



BETEK TUNGSTEN CARBIDE TOOLS



ENVIRONMENTAL  
TECHNOLOGIES

- AGRICULTURE
- GRADER TOOLS
- FORESTRY & RECYCLING

IN USE WORLDWIDE

# TUNGSTEN CARBIDE AND STEEL

Steel and carbide are two materials with totally different expansion coefficients when subjected to heat. Nevertheless, it is of steel and tungsten carbide that our tools are made, with tungsten carbide for the wear-resistant tip, and steel for the tool shank. Since tools reach high temperatures during use, extreme tensile stresses are generated. These stresses are absorbed by a special brazing material that joins the tungsten carbide tip to the steel section.

We have developed our own methods and systems for this brazing process, which is carried out on fully automated machines with the process covered in an inert protective gas. Manufacturing parameters are fully monitored and documented to ensure consistent quality. Afterwards, brazing shear strengths are checked to ensure that our "Masters of the construction site" lose no time due to broken tools!



# BETEK HIGH-TECH TOOLS



1

## CUSTOMER SERVICE

- Efficient, customised solutions based on flexible structures
- Personalised, quick response to customer requirements



2

## DEVELOPMENT & CONSTRUCTION

- Quick creation of samples and prototypes
- Competitive pricing thanks to close cooperation with all production units



3

## TUNGSTEN CARBIDE MANUFACTURING

- High-purity raw materials are used for high strength
- Consistently high, pore-free tungsten carbide quality through precise process control thanks to years of experience and know-how



4

## SOLDERING PRODUCTION UNIT

Production facilities and processes specially developed to perfection by experts in the combination of tungsten carbide and steel



5

#### **AUTOMATION**

Maintaining a competitive edge on the global market thanks to a high degree of automation and flexible manufacturing facilities



6

#### **QUALITY ASSURANCE**

Continuous quality testing of the entire manufacturing chain all the way up to the installation site, in conformity with DIN ISO 9001:2000 and DIN EN ISO 14001



7

#### **TRAINING**

User training courses at BETEK or on-site for sustainable, long-term commercial success and customer satisfaction



8

#### **LOGISTICS**

Quick responses thanks to:

- the use of the very latest IT and enhanced logistics networking
- Standard products kept in stock

OUR KNOW-HOW COMBINED WITH STATE-OF-THE-ART PRODUCTION TECHNOLOGIES GUARANTEES THE FINEST QUALITY, MADE IN GERMANY



## **Over 40 Years of TC Manufacturing Experience**

Tools „Made in Germany“

Experienced, flexible partner for tungsten carbide tools

Customized development of the tools in close cooperation with your local dealer

BETEK provides the optimum tungsten carbide grade for each application, even for the most severe conditions

State-of-the-art technology in engineering and production

---

# TOOL SYSTEMS FOR YOUR GRADER APPLICATION

BETEK is a leading international manufacturer of tungsten carbide and tungsten carbide equipped wear parts. The focal points in our range of products include road milling, foundation drilling, mining, tunnelling and recycling. Grader tools are a further application field of tungsten carbide and a new successful product area at BETEK.

All BETEK tool systems are developed and manufactured at the German company location in Aichhalden in the Black Forest. During the development of tools, the interplay between the cause variables of processing tasks, machines, holder systems and tools take central stage. The basis for the continuous success in the market is system partnerships with machine manufacturers and supplier companies that make BETEK an innovation and technology leader in many areas.

BETEK tungsten carbide tools for graders, snowplows and snow groomers are specifically designed for their application areas. The used tungsten carbide grades ensure high durability and break resistance. In combination with high quality steel bodies BETEK manufactures tool systems that provide excellent support to the performance of modern machines.

A high degree of efficiency is guaranteed through the balance of wear between the tungsten carbide and the steel body, thus insuring the complete use of the tungsten carbide part. This results in quality, time and cost advantages for the customer.

# SCARIFIER BLADES

Available in various diameters

Retainers and tungsten carbide tips are matched exactly to the operating conditions

With various holders and mounting tools

## SHANK SYSTEM

> Ø 19,4 MM/0,76"

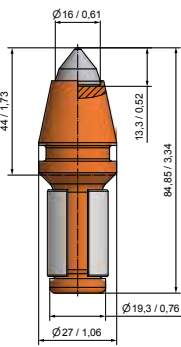

■ BSH09  
B3

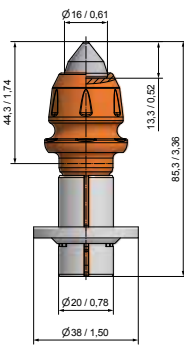

■ BSH219  
BG20H-60.3344

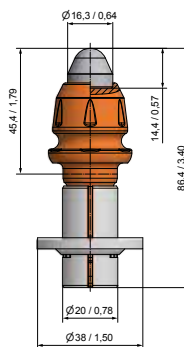

■ BSH254  
BG20H-16.3045

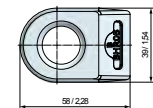
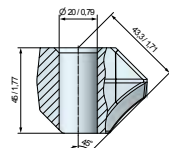

■ BHR05  
B10





➤ Ø 22 MM/0,87"

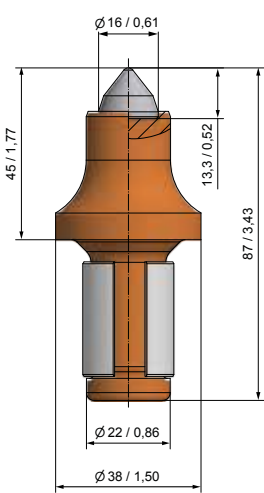

■ **BC41**  
B3S/22 

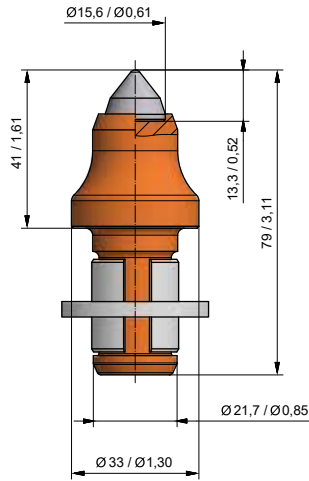

■ **BC133**  
BG22H-60.3845 

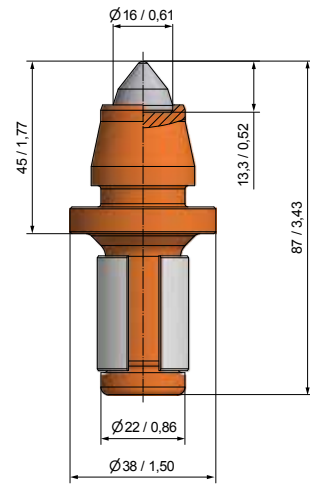

■ **BC81**  
BG22H-60.3845 

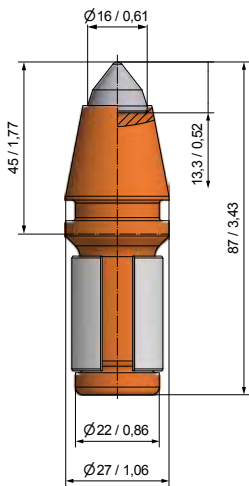

■ **BC49**  
B3/22 

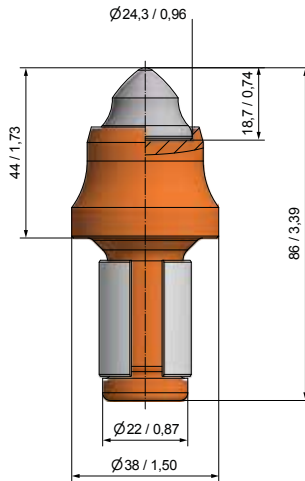

■ **BC43**  
B9/22 

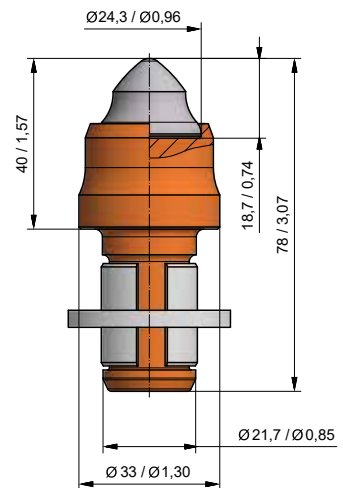

■ **BC132**  
BG22H-68.3844 

# SHANK SYSTEM

► Ø 22 MM/0,87"

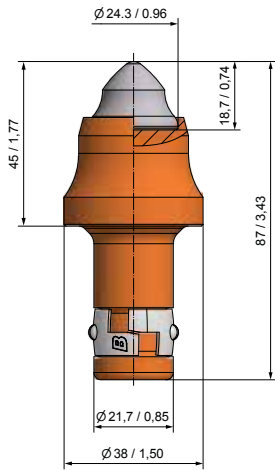

■ **BC70**  
BG22K-68.3845 

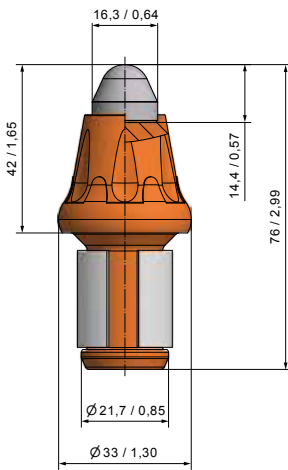

■ **BC72**  
BG22H-16.3342 

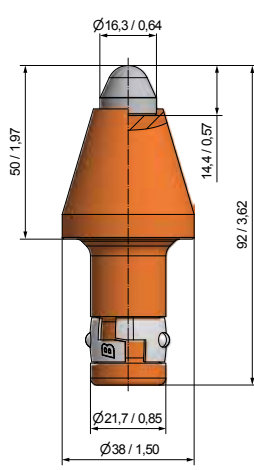

■ **BC73**  
BG22K-16.3850 

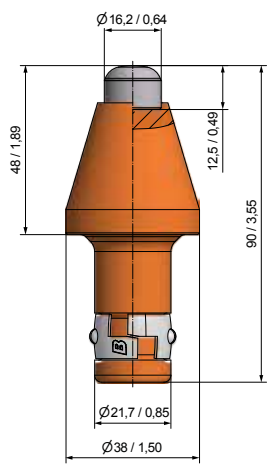

■ **BC74**  
BG22K-16.3848 

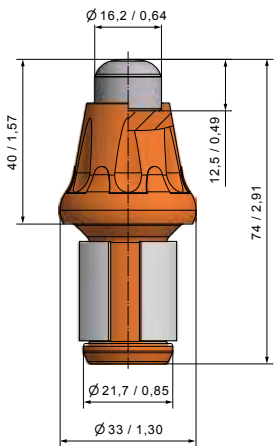

■ **BC75**  
BG22H-16.3340A 

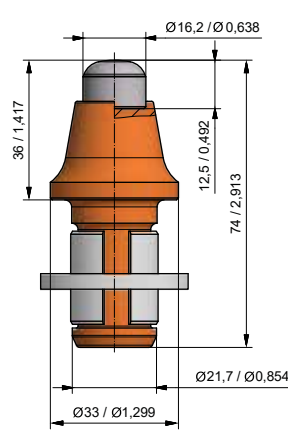

■ **BC131**  
BG22H-16.3840 

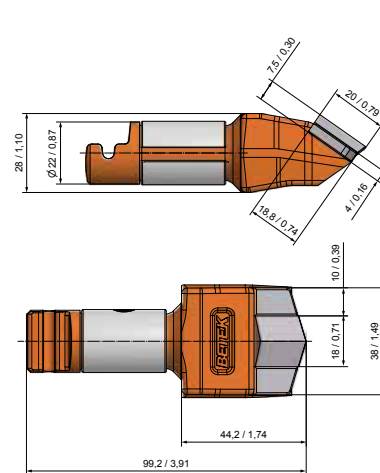

■ **BFR09**  
BFR99x40 

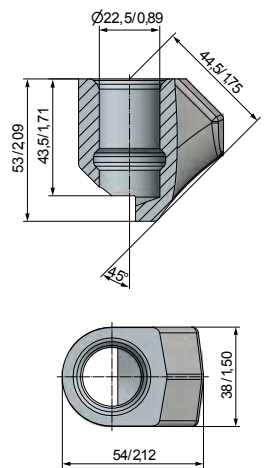

■ **BHR223**  
B22.3845 

> Ø 25 MM/1,0"

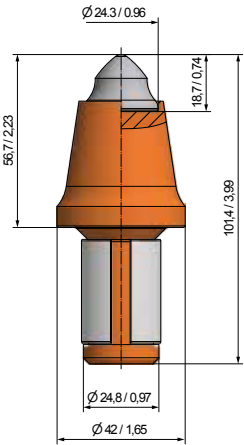

■ BTK134

BG25H-68.4257

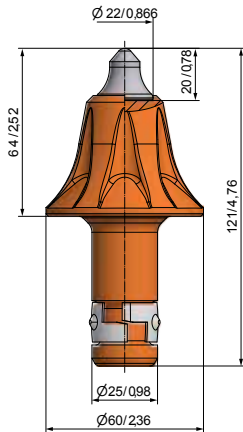

■ BTK80

WR8-E

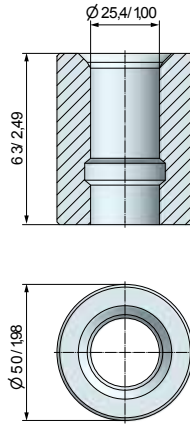

■ BHR167

BHRd=50xBd=25

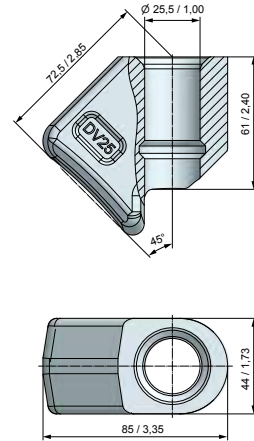

■ BHR31

DV25



# ACCESSORIES



■ BZ04

Assembly

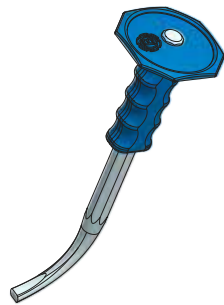

■ BZ43

Disassembly



■ BZ42

Disassembly

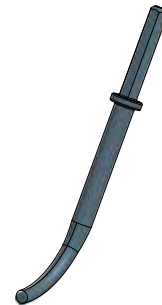

■ BZ46

Disassembly

# TUNGSTEN CARBIDE BLADES

Wear resistant cutting edges with straight or serrated shape

Available in various lengths

Optimum brazing connection between steel body and tungsten carbide inserts

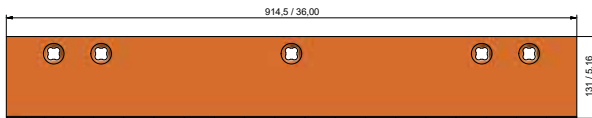
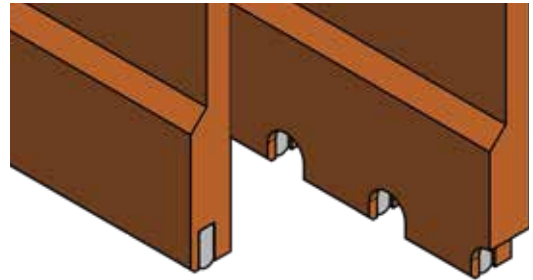

■ **BX93**  
BX915x130x20

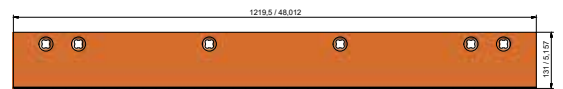

■ **BX94**  
BX1220x130x20

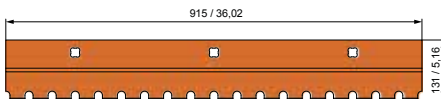

■ **BX76**  
BX915x130x20S

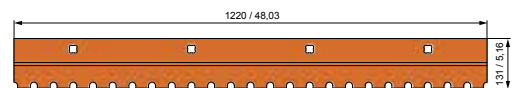

■ **BX77**  
BX1220x130x20S



# SNOW GROOMERS

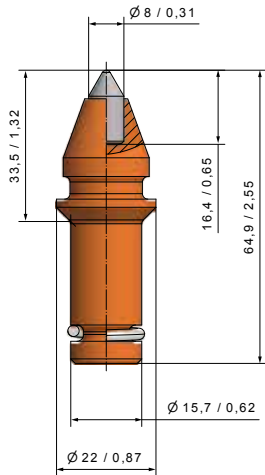

■ **BM08**  
BM8-15.8/FK 

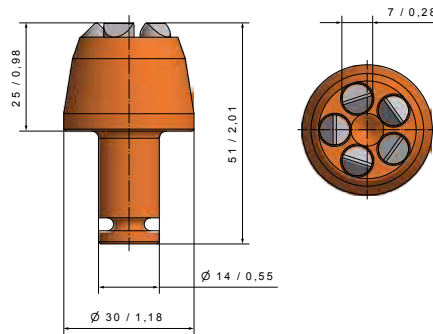

■ **BM69**  
BM7-14/2F 



# EXTENSIVE WEAR PROTECTION



## > OVERVIEW

Betek can provide the appropriate stud welding machine for the TungStuds wear protection system.

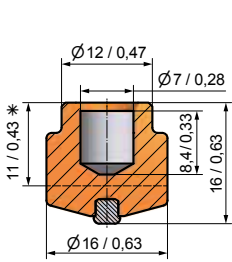

■ **BTS01** BTSD16/16 

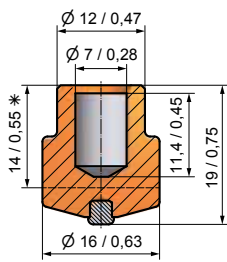

■ **BTS02** BTSD16/19 

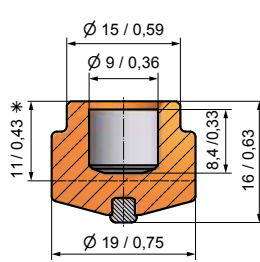

■ **BTS03** BTSD19/16 

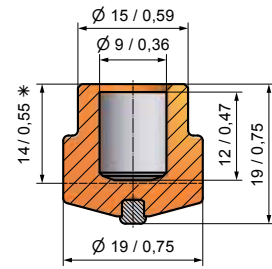

■ **BTS04** BTSD19/19 

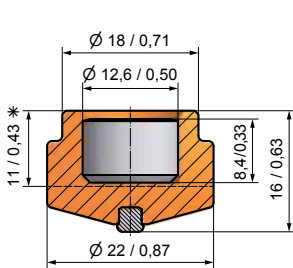

■ **BTS05** BTSD22/16 

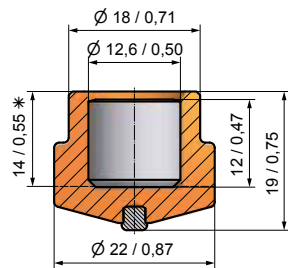

■ **BTS06** BTSD22/19 

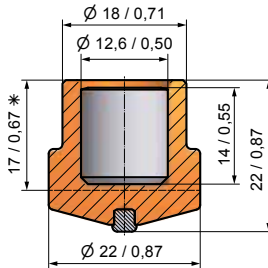

■ **BTS07** BTSD22/22 

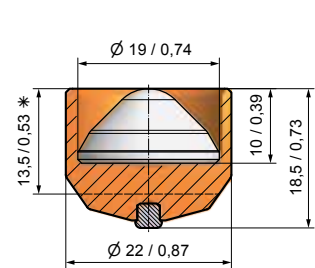

■ **BTS08** BTSD22/18,5SG 

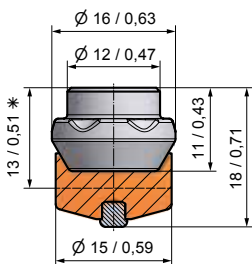

■ **BTS10B** BTSD16/18B 

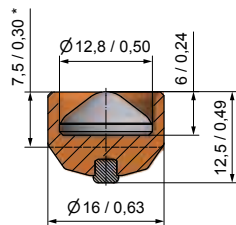

■ **BTS20** BTSD16/12,5SG 

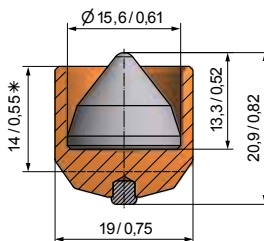

■ **BTS100** BTSD19/15,6SG 

\*Height after welding

# EXTENSIVE WEAR PROTECTION

## ► BTS-PLATES

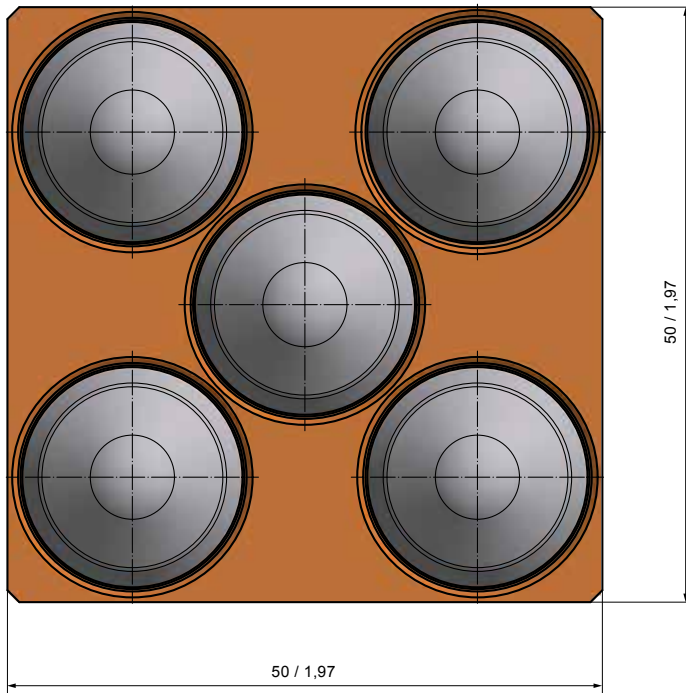
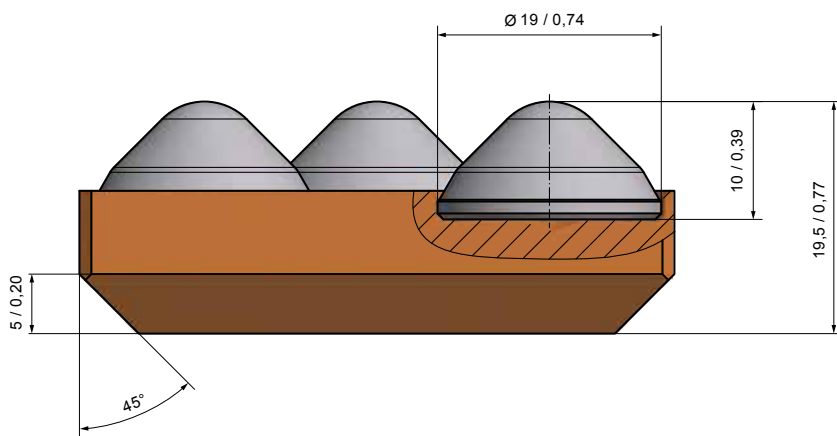

### DIMENSIONS

Width in mm	Length in mm
50	50
75	75
100	100
125	125
150	150

Other sizes on request



## WELDING PROCESS

1

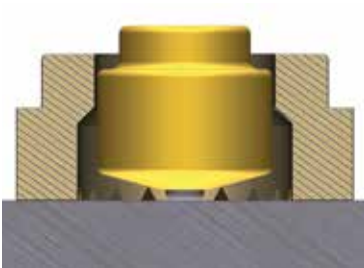

- The TungStud should be placed on the steel surface
- The ceramic ferrule protects the welding area around

2

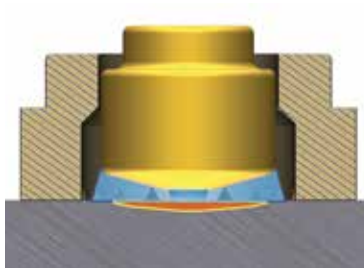

- Current flow is applied
- The TungStud raises up as soon as the arc ignites

3

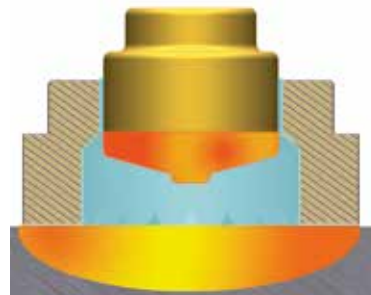

- The arc causes a specific melting of the TungStud and the steel surface

4

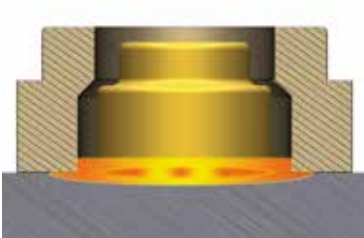

- The TungStud plunges into the melted steel surface

5

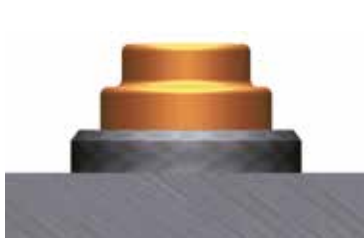

- The welding connection between TungStud and steel surface is completed

### BENEFITS

- Wear resistant thanks to the carbide core
- Quick welding process
- Suitable for uneven surfaces
- Simply replaceable
- Less maintenance > Higher productivity
- Less downtime > Cost reduction

# PERFORMANCE

## › CUTTING WEAR PROTECTION

---

- Grid pattern is recommended
- Cutting wear protection due to the conical carbide shape

### EXTENSIVE WEAR PROTECTION



## › ROCK BOX EFFECT

---

- Grid pattern is recommended
- Rock-Box-Effect due to the cylindrical carbide shape

### EXTENSIVE WEAR PROTECTION

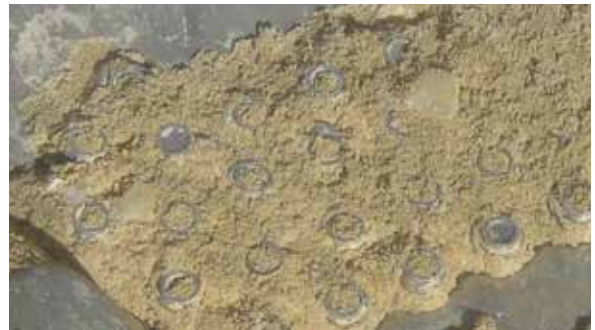



# ➤ BETEK

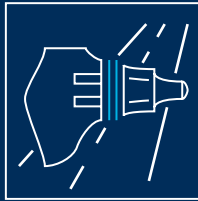

## SURFACE TECHNOLOGIES

- ROAD MILLING
- SURFACE MINING
- STABILISING



## UNDERGROUND TECHNOLOGIES

- FOUNDATION DRILLING
- MINING
- TRENCHLESS
- TRENCHING
- TUNGSTUDS
- DRUM CUTTERS

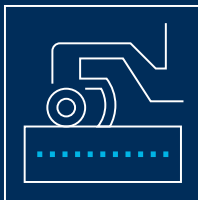

## ENVIRONMENTAL TECHNOLOGIES

- AGRICULTURE
- GRADER TOOLS
- FORESTRY & RECYCLING



## INDUSTRIAL TECHNOLOGIES

- CRUSHING & MIXING
- TUNGSTEN CARBIDE
- RAIL TRACK CONSTRUCTION
- INDUSTRIAL SOLUTIONS

Service number  
+49 (0) 7422. 565-0

info@betek.de  
[www.betek.de](http://www.betek.de)